

TRÅDFRI

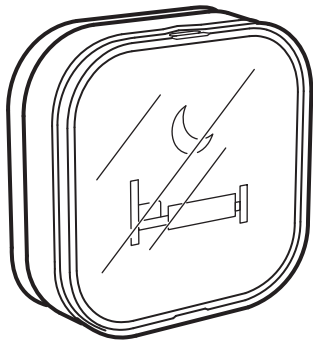

Design and Quality
IKEA of Sweden



English

Different materials require different types of fittings. Always choose screws and plugs that are specially suited to the material.

Deutsch

Verschiedene Materialien erfordern verschiedene Befestigungsbeschlage. Immer Schrauben und Dubel auswahlen, die fur das entsprechende Material geeignet sind.

Franais

Le choix des vis depend du materiel dans lequel elles doivent ˆtre fixees. Utiliser des vis et chevilles adaptees au materiel du support.

Nederlands

Verschillende materialen vereisen verschillende soorten beslag. Zorg dat de schroeven of pluggen die je kiest bestemd zijn voor het materiaal waar ze in vastgezet moeten worden.

Dansk

Forskellige materialer kraver forskellige typer skruer og rawlplugs. Valg altid skruer og rawlplugs, som egner sig til det relevante materiale.

islenska

Nota þarf mismunandi festingar  mismunandi veggum. Veljið alltaf skrufur og tappa sem henta efninu  veggnum.



Norsk

Ulike materialer krever forskjellige typer skruer og beslag. Tenk på at skruene eller pluggene du velger skal være tilpasset materialet de skal festes i.

Suomi

Erilaisiin materiaaleihin tarvitaan erilaiset kiinnikkeet. Valitse kotisi materiaaleihin sopivat ruuvit ja tulpat.

Svenska

Olika material kräver olika typer av beslag. Tänk på att skruvarna eller pluggarna du väljer ska vara avsedda för materialet de ska fästa i.

Español

Diferentes materiales requieren diferentes clases de herrajes. Recuerda que los tornillos y tacos que elijas se deben adaptar al material en el que irán sujetos.

Portugues

Os diferentes tipos de materiais requerem diferentes tipos de fixações. Escolha sempre parafusos e buchas especialmente apropriados para cada material.



Ελληνικά

Τα διαφορετικά εξαρτήματα απαιτούν και διαφορετικούς τύπους εξαρτημάτων. Επιλέγετε πάντοτε βίδες και βύσματα, τα οποία να είναι κατάλληλα για το αντίστοιχο υλικό.

Türkçe

Farklı materyaller farklı türde bağlantı parçaları gerektirir. Her zaman materyale uygun vida ve prizleri tercih edin.

عربي

المواد المختلفة تتطلب أنواع مختلفة من التركيبات. إختار البراغي والمقابس التي تناسب خاصية المادة.

Italiano

Materiali diversi richiedono tipi diversi di accessori di fissaggio. Scegli viti e tasselli adatti al materiale a cui vanno fissati.

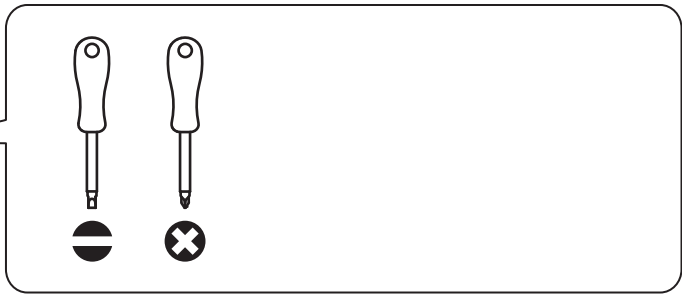

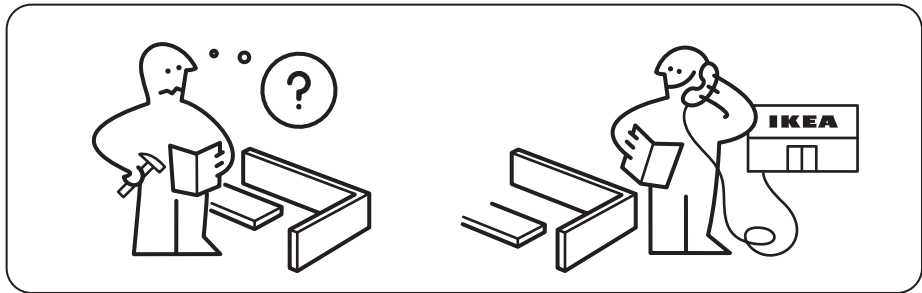

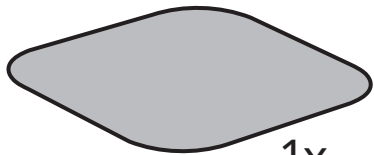

1x

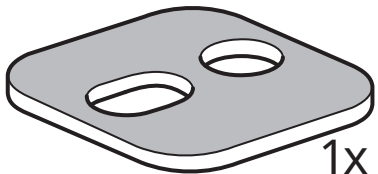

1x

190011

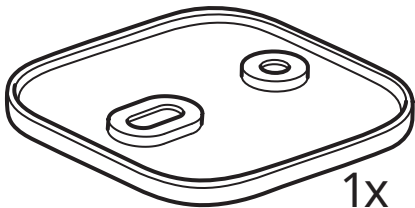

1x

190013

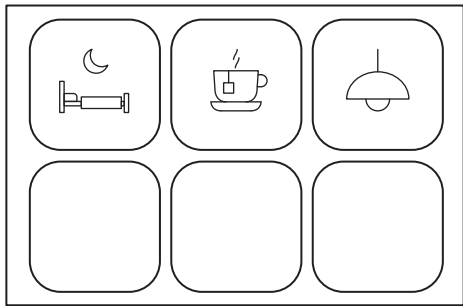

1x



1x

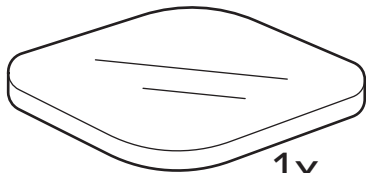

1x

1

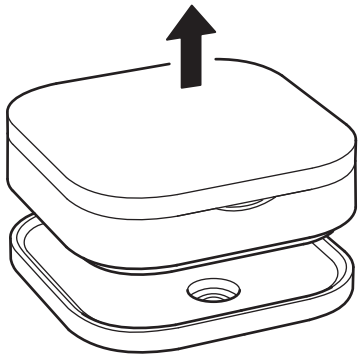

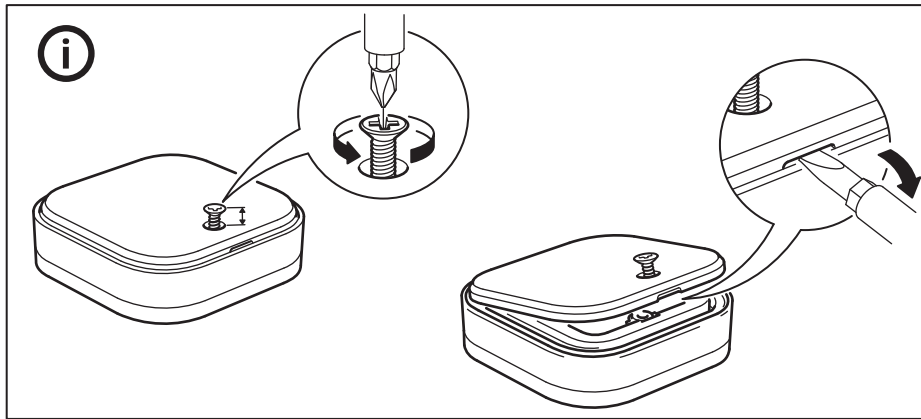



Click!

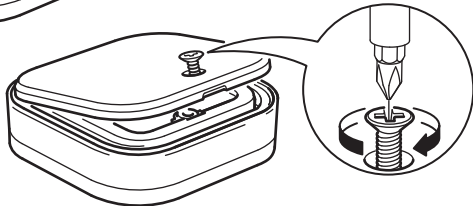
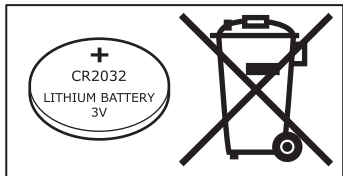

2

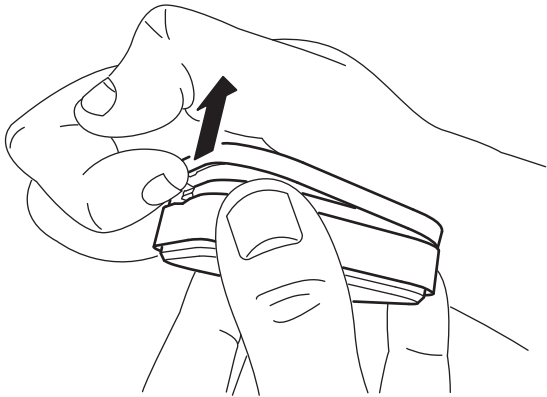

3

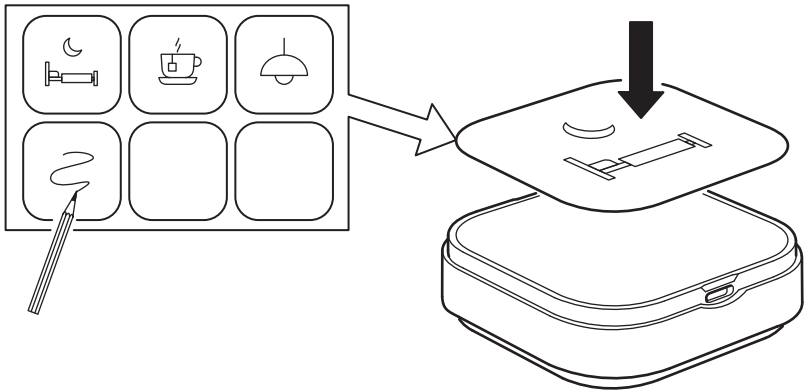

4

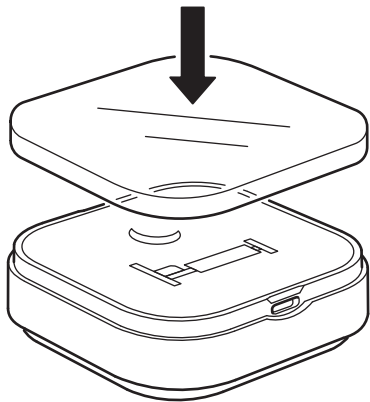



English

Keep battery out of children's reach. To swallow a battery could be fatal. If this happens seek medical attention at once. Before disposal always cover the battery in plastic tape to avoid possible short circuit.

SAVE THESE INSTRUCTIONS.

Deutsch

Batterien außer Reichweite von Kindern halten. Das Verschlucken einer Batterie kann lebensbedrohliche Folgen haben. Nötigenfalls sofort einen Arzt aufsuchen. Vor dem Entsorgen der Batterie die Pole mit Klebeband abkleben, um Kurzschluss zu vermeiden.

DIESE ANLEITUNG AUFBEWAHREN.

Français

Gardez la pile hors de portée des enfants. Avaler une pile peut être fatal. Si cela se produit, appelez immédiatement un médecin. Avant de mettre la pile au rebut, couvrez-la d'une bande plastique pour éviter tout court-circuit.

CONSERVER CES INSTRUCTIONS

Nederlands

Houd batterijen buiten bereik van kinderen. Het inslikken van een batterij kan levensbedreigend zijn. Zoek onmiddellijk medische hulp wanneer dit onverhoopt gebeurt. Om het risico op kortsluiting te voorkomen, de batterij altijd afdekken met plakband/kunststof tape voordat je hem wegdoet.

BEWAAR DEZE INSTRUCTIES.



Dansk

Batteriet skal opbevares utilgængeligt for børn. Det kan være livsfarligt at sluge et batteri. Søg straks lægehjælp, hvis det sker. Før bortskaffelse skal batteriet altid dækkes med plasttape for at forhindre kortslutning.

GEM DISSE ANVISNINGER.

Íslenska

Geymið rafhlöður þar sem börn ná ekki til. Það getur verið banvænt að gleypa rafhlöður. Ef það gerist skal leita strax til læknis. Hyljið rafhlöðurnar með plast límbandi áður en þeim er fargað til að koma í veg fyrir mögulegt skammhlaup. GEYMIÐ ÞESSAR LEIÐBEININGAR.

Norsk

Hold batterier utilgjengelig for barn. Å svelge et batteri kan være livsfarlig. Ta kontakt med din lege umiddelbart hvis dette skulle skje. For å unngå risiko for kortslutning, dekk alltid batteriet med plasteip før du kasserer det.

SPAR PÅ DISSE INSTRUKSJONENE.

Suomi

Säilytä paristot/akut lasten ulottumattomissa. Pariston/akun nielaiseminen saattaa olla hengenvaarallista. Jos lapsi nielaisee pariston/akun, hakeutukaa välittömästi lääkäriin hoitoon. Oikosulun välttämiseksi pariston/akun navat tulee peittää muoviteipillä ennen sen hävittämistä. SÄILYÄ NÄMÄ OHJEET.



Svenska

Håll batterier utom räckhåll för barn. Att svälja ett batteri kan vara livshotande. Sök genast medicinsk vård om det inträffar. För att undvika risken för kortslutning, täck alltid batteriet med plasttejp innan du kasserar det.
SPARA DESSA INSTRUKTIONER.

Español

Mantén la pila fuera del alcance de los niños. Ingerir una pila podría ser fatal. En caso de que suceda, acude inmediatamente al médico. Antes de desecharla cubre la pila con plástico para evitar cortocircuitos.
GUARDA ESTAS INSTRUCCIONES.

Portugues

Mantenha a pilha fora do alcance das crianças. Engolir uma pilha pode ser fatal. Se tal acontecer consulte de imediato um médico. Antes de se desfazer da pilha, cubra-a com fita-cola para evitar possíveis curto-circuitos.
GUARDE ESTAS INSTRUÇÕES.

Ελληνικά

Φυλάξτε την μπαταρία μακριά από παιδιά. Η κατάποσή της μπορεί να προκαλέσει ακόμα και το θάνατο. Εάν αυτό συμβεί, αναζητήστε άμεσα ιατρική φροντίδα. Πριν την απόρριψή της, τυλίξτε την με πλαστική ταινία για την αποφυγή βραχυκυκλώματος.
ΦΥΛΑΞΤΕ ΑΥΤΕΣ ΤΙΣ ΟΔΗΓΙΕΣ.



Türkçe

Pilleri çocuklardan uzak tutunuz. Pilin yutulması ölümcül kazalara sebep olabilir. Böyle bir kaza yaşanırsa mutlaka tıbbi yardım alınmalıdır. Olası kısa devre riskine karşı pilleri çöpe atmadan önce her zaman bir bant yardımıyla sarınız. BU TALİMATLARI SAKLAYINIZ.

عربي

أبقي البطارية بعيداً عن متناول الأطفال. ابتلاع البطارية يمكن أن يؤدي للموت. وإذا حدث ذلك التمس العناية الطبية على الفور. قبل التخلص من البطارية ينبغي دائماً تغطية البطارية بشريط من البلاستيك لتجنب إلتماس كهربائي محتمل. يرجى الإحتفاظ بهذه التعليمات.

Italiano

Tieni la batteria fuori dalla portata dei bambini. Ingerire una batteria può essere fatale. Se dovesse succedere rivolgiti immediatamente a un medico. Prima dello smaltimento copri la batteria con del nastro in plastica per evitare un eventuale cortocircuito. CONSERVA QUESTE ISTRUZIONI.

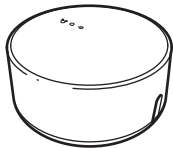

IKEA Home smart



IKEA Home smart

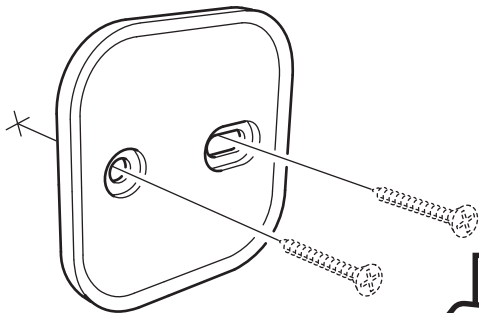
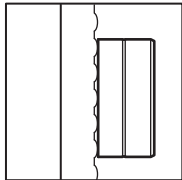
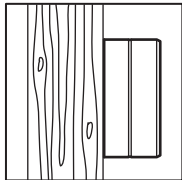

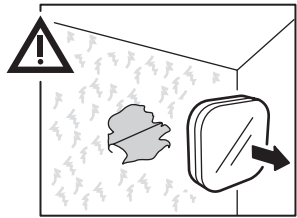
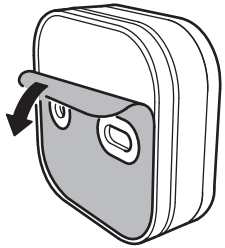
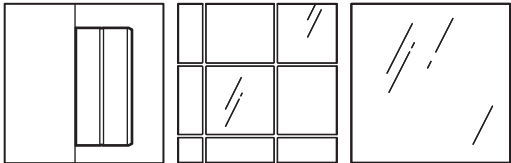

5

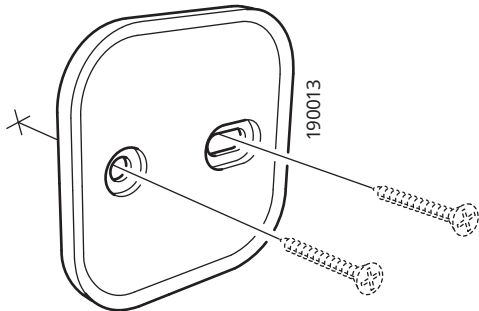
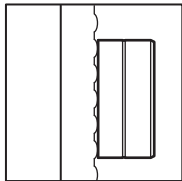
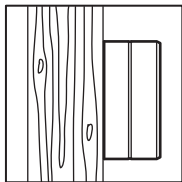

6

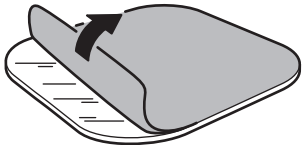

7

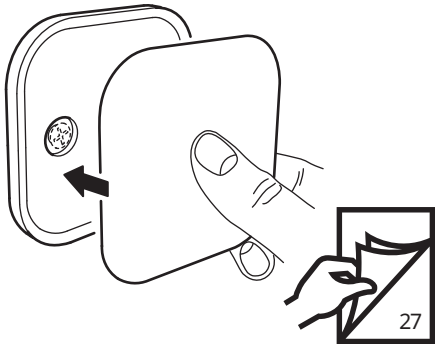

5

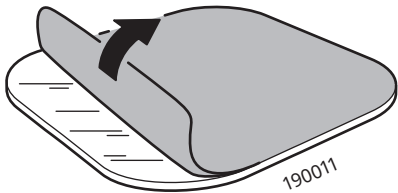
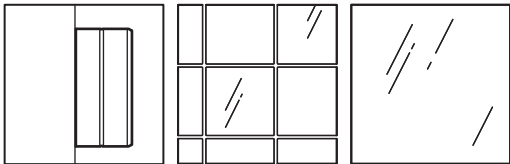

6

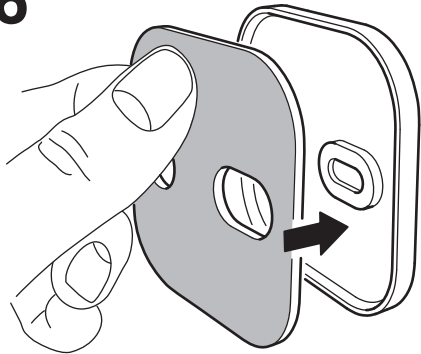

7

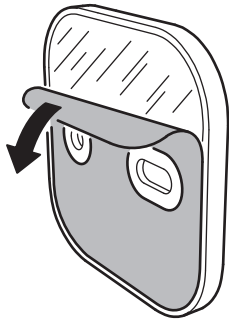

8

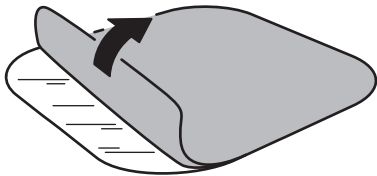

9

